

Scleral Shields / Scleral Depressors / Lid Plates / Dissectors



Sclera! Shield
Stainless steel
DMS 0010 Small
DMS 0012 Large

Schepens Sclera! Depressor
DMS 0025 Small
DMS 0027 Medium
DMS 0029 Large

Jaeger Lid Plate
stainless steel
DMS 0040

Trabut Lid Plate
DMS 0045

Dastoor Lacrimal Sac Dissector
DMS 0050

Schocket Sclera! Depressor
DMS 0020

Blumenthal Conjunctiva Dissector
with blunt disc shaped tip DMS 0055

Muscle Hooks

Graefe Muscle Hook
DMS 0105 Size 1
DMS 0106 Size 2
DMS 0107 Size 3

Helveston Muscle Hook
DMS 0111 8mm
DMS 0112 10mm
DMS 0113 12mm

Jameson Muscle Hook
DMS 0116 Small
DMS 0117 Large

Green Muscle Hook
DMS 0125

Stevens Tenotomy Hook
DMS 0130

Helveston Teaser Hook
DMS 0134

Gass Retinal Detachment Hook
with oval hole DMS 0136

Helveston Finder Hook
DMS 0139 Small
DMS 0140 Large

IOL Manipulators

Lester IOL Manipulator
DMS 0205 Straight
DMS 0206 Angled

Keuch Small Pupil Dilator
DMS 0214

Bonn Micro Iris Hook
DMS 0220

Smith Lens Expressor
DMS 0228

Sinsky Lens Manipulating Hook
DMS 0234 Straight
DMS 0235 Angled

Kuglen Iris Hook and Lens Manipulator
Push Pull model
DMS 0248 Straight
DMS 0249 Angled

Rentsch Boat Hook with Guard
DMS 0252

IOL Manipulators / Nucleus Manipulators

Fenzl Lens Manipulating Hook
DMS 0256 Straight
DMS 0257 Angled

Fixation Hook
Double sharp
DMS 0269 Small
DMS 0270 Large

Akahoshi Nucleus Sustainer
DMS 0405

Lieberman MicroFinger Nucleus Manipulator
DMS 0408

Jaffe-Beichert Nucleus Rotator
forked tip angled at 9mm
DMS 0411

Clayman Nucleus Rotator
V-notched tip
DMS 0414

Drysdale Nucleus Manipulator
DMS 0417

Choppers / Nucleus Fragmenters

Siepsner Endocapsular Controller
DMS 0420

Chang Combination Chopper
DMS 0523 Right
DMS 0524 Left

Dodick-Kammann Nucleus Chopper
DMS 0535 Straight tip, 1.5 mm
DMS 0536 Angled tip, 1.5 mm
DMS 0537 Straight tip, 2.0 mm
DMS 0538 Angled tip, 2.0 mm

Fukasaku Snapper Hook
DMS 0545

Rosen Phaco Splitter
DMS 0549

Bucher Kansas Nucleus Trisector
2.5mm wide
DMS 0608

Alfonso Nucleus Trisector
DMS 0612

Nucleus Fragmenters / Markers

Alfonso Cutting Platform
DMS 0614 2mm wide
DMS 0616 3mm wide

Kansas Nucleus Bisector
DMS 0620

Kansas Nucleus Trisector
4mm wide
DMS 0622

Kansas Nucleus Vectis
Cutting block for nucleus bisector & trisector
DMS 0624

Mandel Intra-Operative Keratometer
ring shaped
DMS 0705

Fechtner Trabeculectomy Marker
DMS 0710

Chayet Corneal Marker
DMS 0714

Anis Radial Marker
DMS 0743 8 Blade
DMS 0745 12 Blade
DMS 0747 16 Blade

Anis Corneal Suturing Marker
8 radial blade, 8mm center opening
DMS 0749

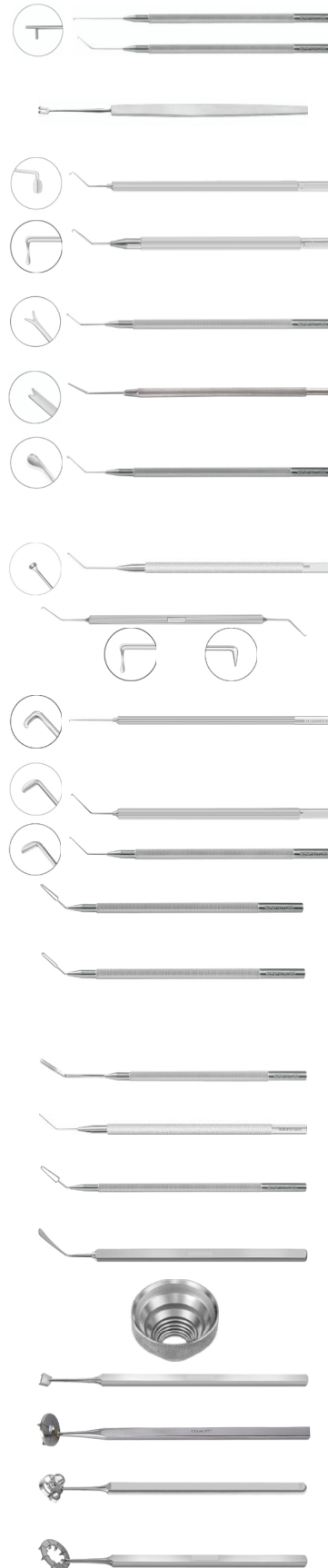

sales@devinemeditech.com

<http://www.devinemeditech.com/>

Web Search

Nucleus Fragmenters / Markers

Bores Optic Zone Marker

DMS 0755 3.00 mm
DMS 0756 3.25 mm
DMS 0757 3.50 mm
DMS 0758 3.75 mm
DMS 0759 4.00 mm
DMS 0760 4.25 mm
DMS 0761 4.50 mm
DMS 0762 4.75 mm
DMS 0763 5.0 mm
DMS 0765 6.0 mm
DMS 0767 7.0 mm
DMS 0769 8.0 mm
DMS 0771 9.0 mm



Speculums

Barraquer Wire Speculum

DMS 1000 Child, 10mm blade
DMS 1001 Adult, 15mm blade
DMS 1010 Heavy wire, 15mm blade



Infant Lid Speculum

closed wire blade, 4mm
gently curved springs
DMS 1012



Barraquer Wire Speculum

solid blade
DMS 1019 Child
DMS 1020 Adult



Kratz-Barraquer Wire Speculum

with open blade
DMS 1021 Child
DMS 1022 Adult



Castroviejo Eye Lid Speculum

adjustable mechanism
DMS 1029 Small
DMS 1030 Medium



Cook Eye Speculum

solid blade, with locking screw
DMS 1034 Small
DMS 1035 Medium
DMS 1036 Large



Lester-Burch Eye Speculum

solid blade with flanges
adjustable mechanism with locking screw
DMS 1038



Lancaster Eye Speculum

solid blade
adjustable mechanism
DMS 1040



Clarks Eye Speculum

open blade
DMS 1041



Williams Eye Speculum

open blade
DMS 1044 Small
DMS 1045 Large



Sauer Eye Speculum

11mm blade
DMS 1050



McPherson Eye Speculum

13mm blade
DMS 1055



Maumenee-Park Eye Speculum

with canthus hook
blade locking screws
DMS 1056 Solid Blade
DMS 1057 Fenestrated Blade



Lieberman Aspirating Speculum

with Kratz style 15mm blade adjustable
mechanism
DMS 1062



Speculums

Lieberman Aspirating Speculum

with V-shaped 15mm blade adjustable
mechanism
DMS 1064



Lieberman Eye Speculum K-shaped Wire Blade

Kratz style open wire blade adjustable mechanism
DMS 1070



Lieberman Eye Speculum

adjustable mechanism
DMS 1072 Solid Standard Blade
DMS 1073 Solid Small Blade

Retractors

DMSmarres Lid Retractor

thin solid blade
DMS 1100 Size 0
DMS 1101 Size 1
DMS 1102 Size 2
DMS 1103 Size 3

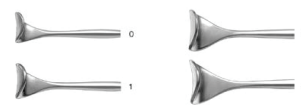

Dastoor Iris Retractor

DMS 1105



Jaffe Lid Retractor

DMS 1109 Small
DMS 1110 Large

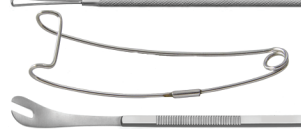

Schepens Forked Orbital Retractor

DMS 1120

Retractors / Fixation Rings

Knapp Retractor

4 prongs
DMS 1125 Blunt
DMS 1126 Sharp



Stevenson Retractor

3x3 prongs
adjustable
DMS 1130



Stevenson Retractor

solid blade
adjustable
DMS 1132



Lang's Lacrimal Sac Dissector

DMS 1140



Mueller Lacrimal Sac Retractor

3x3 prongs
DMS 1160



Thornton Globe Fixation Ring

multiple teeth
DMS 1246



Hofmann-Thornton Globe Fixation Ring

16mm diameter ring multiple teeth
DMS 1255



McNeill Global Fixation Ring

DMS 1256



Flieringa Rings

Set of 8, 15mm-22mm
DMS 1258



Gimbel Stabilization Ring

DMS 1263



Fine-Thornton Swivel Fixation Ring

DMS 1264



Calipers

Castroviejo Caliper

20mm
DMS 1300 Straight
DMS 1302 Angled
DMS 1305 Curved



Oscher Incision Caliper

DMS 1308



Helveston Sclera! Ruler

15mm long
single marking tooth at tip
DMS 1315



sales@devinemeditech.com

<http://www.devinemeditech.com/>

Web Search



Blade Breakers

- Castroviejo Blade Breaker & Holder**
DMS 1400
- Troutman Blade Holder**
DMS 1402
- Swiss Model Blade Breaker & Holder**
DMS 1405

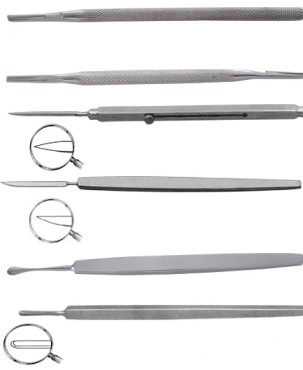

B.P. Handle / Knives

- Bard-Parker Blade Handle**
DMS 1408 No. 3
DMS 1409 No. 9
- Bard Parker Blade Handle**
double
DMS 1410
- Barraquer Cataract Knife**
in sliding case
DMS 1415
- Von Graefe Cataract Knife**
DMS 1420
- Gill Corneal Knife**
DMS 1424 Curved
DMS 1425 Straight
- Tooke Corneal Knife**
straight blade with
curved cutting edge
DMS 1430

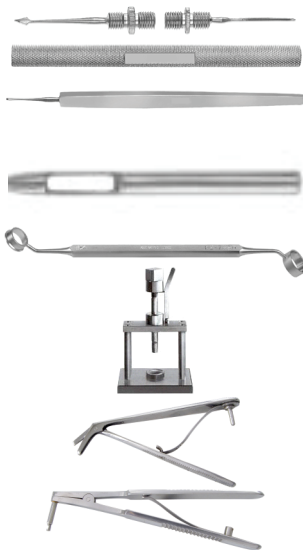

Spuds / Trephines / Punches

- Foreign Body Spud & Needle**
DMS 1450
- Ellis Foreign Body Spud**
lightly curved and rounded
tip
DMS 1455
- Elliot Sclera! Trephine Blade**
DMS 1465 1.0mm
DMS 1466 1.5mm
DMS 1467 2.0mm
- Camellin Style Lasek Trephine & Well**
DMS 1470 8mm trephine with 8.5mm well
DMS 1471 9mm trephine with 9.5mm well
- Liberman Corneal Donor Button Punch**
gravity action
DMS 1480
- Hoth Corneoscleral Punch**
DMS 1490
- Gass Corneoscleral Punch**
DMS 1492

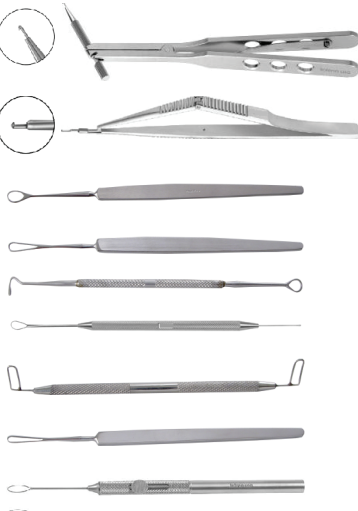

Punches / Loops

- Luntz-Dodick Trabeculectomy Punch**
1.0mm diameter head
with bullet shaped tip
DMS 1493
- Kelly Membrane Punch**
1.0mm diameter head
0.75mm deep bite
DMS 1494
- Lewis Lens Loop**
DMS 1500 Large
DMS 1501 Small
- Wilder Lens Loop, serrated**
DMS 1515
- Kirby Lens Loop & Muscle Hook**
DMS 1520
- Morrison Lens Loop and Probe**
DMS 1525
- Simcoe Lens Nucleus Loop**
double end
DMS 1530
- Kansas Lens Loop**
serrated, 3mm wide
DMS 1532
- Keener Lens Divider**
DMS 1540



Spoons / Curettes & Cauteries

- Barraquer Lenticular Spoon**
for corneal button transfer
DMS 1700
- Wells Enucleation Spoon**
DMS 1710
- Bunge Evisceration Spoon**
DMS 1712 Small
DMS 1714 Large
- Mule Evisceration Spoon**
DMS 1718
- Meyer Hoefer Chalazion Curette**
DMS 1720 Size 0
DMS 1721 Size 1
DMS 1722 Size 2
DMS 1723 Size 3
DMS 1724 Size 4
- Nightingale Capsule Polishing Curette**
DMS 1730
- Anis Capsule Scrubber**
DMS 1731
- Gills Capsule Polishing Curette**
DMS 1735
- Heat Cautery Standard Copper Ball**
DMS 1740

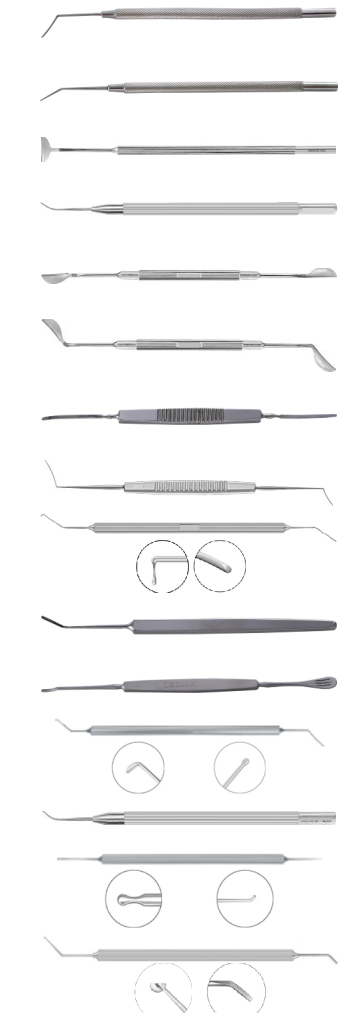

Spatulas / Repositors / Flap Protectors

- Barracier Iris Spatula**
DMS 1798 0.25 mm
DMS 1800 0.50 mm
- Gimbel Nucleus Spatula**
angled 30°, 0.25mm dia.
DMS 1801
- Buratto LASIK Flap Protector**
DMS 1802
- Sloane Lasek Flap Repositor**
gently curved spatulated tip
DMS 1803
- Buratto Lasik Flap Protector**
blade angled 15°
DMS 1805
- Mannis-Buratto Lasik Flap Protector**
blade angled 45°
DMS 1808
- Wheeler Iris Spatula**
double ended
DMS 1810
- Castroviejo Synechia Spatula**
0.5mm wide with semi-sharp tips
DMS 1820
- Lieberman MicroFinger and Spatula**
DMS 1822 Right
DMS 1823 Left
- Elschnig Cyclodialysis Spatula**
1mm wide
DMS 1825
- Paton Spatula & Spoon**
DMS 1830
- Masket Phaco Spatula**
DMS 1832
- Guimaraes Lasik Spatula**
gently curved
DMS 1883
- Katzen Lasik Flap Unzipper**
DMS 1894
- Sloane Lasek Micro Hoe & Epi Peeler**
DMS 1896



sales@devinemeditech.com

<http://www.devinemeditech.com/>

Web Search

Forceps

Jewelers Forceps
DMS 1954

Utrata Capsulorrhexis Forceps
extremely thin 11 mm long shanks
triangular grasping tips
DMS 1962 Round handle with
guide pin

Jaffe Capsulorrhexis Forceps
round grasping tips
DMS 1966

Livernois IOL Folding Forceps
concave jaws
DMS 1979

Dodick IOL Folding Forceps
DMS 1980

Buratto Soft IOL Inserting Forceps
convex jaws DMS 1981

Botvin Iris Forceps
1x2 teeth
DMS 2008

Bonn Forceps
1x2 teeth, Short
model
DMS 2020

Bonn Forceps
1x2 teeth, tying platform, long
model
DMS 2022

Harms Colibri Forceps
1x2 teeth with tying platform
DMS 2045

Gills-Colibri Forceps
pointed tips
DMS 2048

Colibri Forceps
standard 1x2 teeth
with tying platform
DMS 2049

Colibri Forceps
fine 1x2 teeth, angled
DMS 2050

McPherson Corneal Forceps
1x2 teeth, 0.4 mm
with tying platform
DMS 2060 Straight
DMS 2061 Curved
DMS 2062 Angled

Pierse-Colibri Corneal Forceps
1x1 teeth
DMS 2072

Hoskin Tissue Forceps
straight
DMS 2074

Pierse Corneal Forceps
straight 1x1 teeth
DMS 2075

Castroviejo Suturing Forceps
1x2 teeth
with tying platform
DMS 2078 Straight 0.90mm
DMS 2079 Straight 0.50mm
DMS 2080 Straight 0.12mm
DMS 2081 Straight 0.30mm
DMS 2082 Angled

Bores Corneal Fixation Forcep
U shaped
DMS 2085

Moorfield Suture Forceps
serrated jaws
DMS 2090

Sauer Fixation Forceps
1x2 teeth
DMS 2092

Forceps

Polack Double Corneal Fixation Forceps
1x2 teeth
DMS 2087

St. Martin Suture Forceps
1x2 teeth
with tying platform
DMS 2105

Manhattan Eye & Ear Suture Forceps
1x2 teeth
with tying platform
DMS 2104

Lim's Corneoscleral Forceps
1x2 teeth
with tying platform
DMS 2110

Dastoor Superior Rectus Forceps
1x2 teeth
DMS 2116

Troutman Superior Rectus Forceps
angled
1x2 teeth
DMS 2115

Tissue Forceps delicate
1x2 teeth
DMS 2117 Standard Straight
DMS 2118 Delicate Straight
DMS 2119 Delicate Curved

Graefe Fixation Forceps
multi teeth
DMS 2120

Lester Fixation Forceps
straight
DMS 2122 1x2 teeth
DMS 2123 2x3 teeth

Green Fixation Forceps
multiple teeth
DMS 2125 Without catch
DMS 2126 With catch

McPherson Suture Tying Forceps
7 mm long smooth jaws angled
DMS 2127

Bechert Forceps
10mm long smooth jaws angled
DMS 2129

McPherson Suture Tying Forceps
5mm long smooth jaws
DMS 2130 Straight
DMS 2132 Angled

Jaffe Tying Forceps
smooth jaws, very delicate
DMS 2136

Jayle Tying Forceps
DMS 2137

Gerl Tying Forceps
DMS 2138 Straight
DMS 2139 Angled
DMS 2140 Curved

Sinsky Tying Forceps
DMS 2141 Straight
DMS 2144 Angled

Tennant Tying Forceps
DMS 2146 Straight
DMS 2147 Curved

Maumenee Tying Forceps
DMS 2148

Helveston Tying Forceps
DMS 2149

 sales@devinemeditech.com

<http://www.devinemeditech.com/>

Web Search

Forceps



Barraquer Cilia Forceps
curved smooth jaws
DMS 2150

Buratto Lasik Flap Forceps
DMS 2152

Mendez Multi Purpose Lasik Forceps
spatulated jaws and tips
DMS 2153

Kelman McPherson Lens Holding Forceps
cross action
DMS 2155

Kratz Lens Holding Forceps
curved
DMS 2158

BlayDMS Lens Holding Forceps
angled
DMS 2160

Clayman Lens Holding Forceps
angled
DMS 2165

Shepard Lens Holding Forceps
gently curved
DMS 2170

Sinsky Lens Holding Forceps
T Shape Lower Jaw
DMS 2174

Akahoshi Phaco Pre Chopper
4.5mm long delicate jaws
DMS 2176

Dodick Nucleus Cracker
DMS 2178

Ernest Nucleus Cracker
DMS 2180

Bishop Harman Dressing Forceps
serrated tips
DMS 2190

Bishop Harman Tissue Forceps
1x2 teeth
DMS 2191 Delicate
DMS 2192 Standard

Arruga Capsule Forceps
DMS 2195

Dressing Forceps
serrated delicate
DMS 2200 Straight
DMS 2202 Curved

Beer Cilia Forceps
1mm wide
DMS 2205

Bonaccolto Conjunctiva Forceps
cross serrations at tips
DMS 2207 1.2mm
DMS 2208 1.7mm

Nugent Utility Forceps
DMS 2210 Smooth jaws
DMS 2212 Serrated jaws

Watzke Sleeve Spreading Forceps
DMS 2218

Snellen Entropium Forceps
DMS 2220 Left
DMS 2222 Right

Forceps



Lambert Chalazion Forceps
round small
DMS 2229

Hunt Chalazion Forceps
round large
DMS 2230

Baird Chalazion Forceps
oval small
DMS 2231

Francis Chalazion Forceps
oval medium
DMS 2232

Desmarres Chalazion Forceps
oval large
DMS 2234

Jameson Muscle Forceps
DMS 2239 Small, Left
DMS 2240 Large, Left
DMS 2241 Small, Right
DMS 2242 Large, Right

Worth advancement Forceps
DMS 2243 Left
DMS 2244 Right

Nasal Packing Forceps
DMS 2245

Berke Ptosis Forceps
DMS 2250

Erhardt Lid Forceps
DMS 2255

Halsted Artery Forceps
DMS 2260 Straight 5 % inch
DMS 2264 Curved 5% inch

Hartman Mosquito Forceps
DMS 2270 Straight 5 % inch
DMS 2272 Curved 5 % inch

Baby Jones Towel Clamp
cross action
DMS 2280
Serrefine
Straight
DMS 2285

Vitreoretinal Forceps
DMS 2290 Serrated jaws, 20G, straight
DMS 2291 Smooth jaws, 20G, straight
DMS 2292 Smooth jaws, 20G, vertical
DMS 2293 Smooth jaws, 1x2 teeth, 20G, straight
DMS 2294 Smooth jaws, end gripping, 20G, straight

Lacrimal & DCR Instruments

Kerrison Bone Nibbling Rongeur
DMS 2302 3.0mm wide
DMS 2303 3.5mm wide
DMS 2304 4.0mm wide
DMS 2305 4.5mm wide

CiteIII Bone Nibbling Rongeur
DMS 2306

Beyer Rongeur
single action
DMS 2310

Nasal Speculum
DMS 2314 Child
DMS 2315 Adult

 sales@devinemeditech.com

<http://www.devinemeditech.com/>

Web Search

Lacrimal & DCR Instruments



Killian Nasal Speculum
DMS 2316

Mallet
DMS 2320

Freer Periosteal Elevator
double end
DMS 2330

Traquair Periosteal Elevator
double end
DMS 2332

West Lacrimal Chisel
DMS 2335

West Bone Gauge
DMS 2336

Harms Trabeculotomy Probe
DMS 2340 Right
DMS 2344 Left

Wilder Lacrimal Dialator
DMS 2350 #1
DMS 2351 #2
DMS 2352 #3

Castroviejo Lacrimal Dialator
double end
DMS 2353

Bowman Lacrimal Probe Set
DMS 2360

Aruga Lacrimal Trephine
with central pin
DMS 2372

Pigtail Probe
DMS 2370

Crawford Retrieving Hook
DMS 2375

Scissors

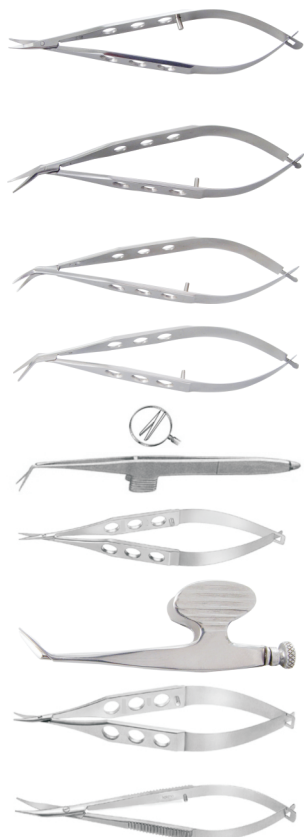

Castroviejo Universal Corneal Scissors
curved, blunt tip
DMS 2500 Small
DMS 2501 Medium
DMS 2502 Large

Troutman Castroviejo Corneo Scleral Scissors
DMS 2508 Medium, Left
DMS 2509 Medium, Right
DMS 2510 Small, Left
DMS 2512 Small, Right

Troutman Katzin Corneal Transplant Scissors
DMS 2515 Left
DMS 2516 Right

Castroviejo Keratoplasty Scissors
angled, blunt tip
DMS 2520

Dewecker Iris Scissors
DMS 2525

Iris Scissors
sharp tip, small blade
DMS 2528 Straight
DMS 2529 Curved

Barraquer Iris Scissors
DMS 2530

McPherson-Westcott Conjunctival Scissors
curved, blunt tip
DMS 2534

Westcott Tenotomy Scissors curved blunt tip
DMS 2535 Medium
DMS 2536 Left
DMS 2537 Right

Scissors



McPherson-Westcott Stitch Scissors
sharp tip
DMS 2545

Fine Stitch Scissors
sharp tip
DMS 2546 Straight
DMS 2547 Curved

Vannas Capsulotomy Scissors
DMS 2560 Straight
DMS 2564 Curved
DMS 2566 Angled

Enucleation Scissors
DMS 2571 Medium curve
DMS 2572 Strong curve

Stevens Tenotomy Scissors
DMS 2575 Straight
DMS 2576 Curved

Knapp Strabismus Scissors
blunt
DMS 2580 Straight
DMS 2581 Curved

Werb Lacrimal Scissors
DMS 2585

Eye Scissors small
DMS 2590 Straight
DMS 2591 Curved

Eye Scissors standard
DMS 2597 Straight
DMS 2598 Curved

Vitrectomy Scissors
DMS 2651 Horizontal opening, straight, 20G
DMS 2652 Horizontal opening, angled 30°, 20G
DMS 2654 Vertical opening, angled 60°, 20G
DMS 2655 Vertical opening, angled 80°, 20G

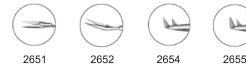

Needle Holders



Barraquer Needle Holder
short model, very delicate jaws, straight
DMS 2705 Without lock
DMS 2706 With lock

Barraquer Needle Holder
short model, very delicate jaws, curved
DMS 2720 Without lock
DMS 2721 With lock

Castroviejo Needle Holder delicate jaws, straight
DMS 2730 With lock
DMS 2731 Without lock

Castroviejo Needle Holder
delicate jaws, curved
DMS 2735 Without lock
DMS 2736 With lock

Kalt Needle Holder
DMS 2740 Straight
DMS 2741 Curved

Silcock Needle Holder
DMS 2745

McPherson Needle Holder
straight
DMS 2760 Without lock
DMS 2763 With lock

McPherson Needle Holder
curved
DMS 2765 Without lock
DMS 2767 With lock

Troutman Needle Holder
DMS 2770 Without lock
DMS 2772 With lock

Micro Needle Holder
for 10.0 sutures
DMS 2779 Straight with lock
DMS 2780 Straight without lock
DMS 2781 Curved without lock
DMS 2782 Curved with lock

Halsted Needle Holder
DMS 2785

 sales@devinemeditech.com

<http://www.devinemeditech.com/>

Web Search

Cannulae

Simcoe I/A Cannula with silicon tubing
DMS 3010 Direct, gold plated
DMS 3015 Reverse, gold plated
DMS 3020 Direct, silver plated
DMS 3021 Reverse, silver plated

J Shaped I/A Cannula
with silicon tubing
DMS 3025

Jenson Capsule Polisher
DMS 3030

Simcoe Posterior Capsule Polisher
DMS 3035

Kratz Capsule Polisher
DMS 3037

Kelman Irritating Cystotome
straight
DMS 3045

McIntyre Cystotome angled
DMS 3047

Kratz Cystotome Formed
DMS 3048

Lacrimal Cannula
DMS 3050 Straight
DMS 3052 Curved

Shahinian Lacrimal Cannula
DMS 3054

Crawford Lacrimal Intubation Set
(2 Probes with attached silicon tubing)
DMS 3055

Bodian Lacrimal Intubation Set
(2 Probes with attached silicon tubing)
DMS 3056

DCR Tube Set
(2 Probes with attached silicon tubing)
DMS 3057

McIntyre Irrigating Cannula
set of 23/25/27/30G
DMS 3058 Angled
DMS 3059 Straight

Rycroft A.C. Air Inlyrr Cannula
angled, set of 4 diff. gauge
DMS 3060

McIntyre Binkhorst Cortex Aspirating Cannula
set of R/L
DMS 3065

McIntyre A.C. Air Iflyrr Cannula
angled, set of 4 diff. gauge
DMS 3068

Cannulae

A.C. Maintainer
silicon tube, cannula with Atkinson point
DMS 3070

Gills Cortical Aspiration Cannula
DMS 3072

Ramsey Air Fluid Exchange Cannula
DMS 3074

Simcoe Cortical Aspiration Cannula
DMS 3075

Vitreoretinal Infusion Cannula
beveled tip, flexible tubing
DMS 3076

Maumenne Vitreous aspiration Cannula
DMS 3077

Grizzard Subretinal Fluid Cannula
DMS 3078

Bishop Harman A/C Irrigator Cannula
with silicon bulb & adaptor
DMS 3080

Alfonso-McIntyre Irrigating Nucleus Spoon
DMS 3081 3.0mm
DMS 3082 4.5mm

Rainin Nucleus Hydro Dissection Cannula
DMS 3084

P. Koch Nucleus Hydrolysis Cannula
DMS 3085

Pearce J shape Hydro Dissection Cannula
DMS 3086

Bidaye Nucleus Delivery Punch
DMS 3087

Knole Pearce Irrigating Vectis for Lens Removal
3 port
DMS 3088

Drews - Knolle Reverse Irrigating Vectis for Lens Removal
DMS 3090

Sheets Irrigating Vectis for Lens Removal
DMS 3091

Simcoe Irrigating Lens Nucleus Loop
set of R/L
DMS 3092

Randolph Cyclodialysis Cannula
DMS 3095

Kelman Cyclodialysis Cannula
set of R/L
DMS 3096